



电子元器件系列(中国.厦门) China.Xiamen  
*www.rf-china.com* RF-Micom co.,Ltd







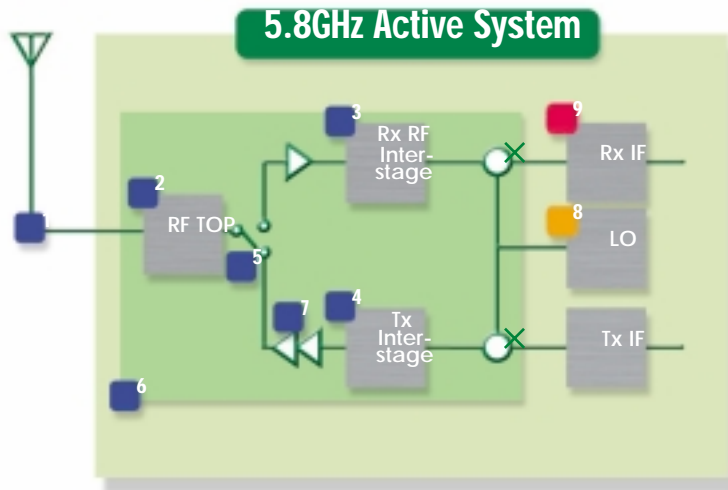









**Email:sales@rf-china.com**

**Telephone:0086-592-5713956 Fax:5201617**

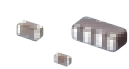
# ETC/DSRC



## 5.8GHz Active System

- |  |   |  |   |   |   |
|--|---|--|---|---|---|
| <p><b>1</b></p> <p>同轴连接器<br/>MM8430-2600B</p>                           | <p><b>2 3 4</b></p> <p>GIGAFIL®<br/>MB系列</p>  <p>3.6x3.0x1.6mm</p>       | <p><b>2 3 4</b></p> <p>片状多层LC滤波器<br/>LFB31_SN系列</p>  <p>3.2x1.6x1.3mm</p> | <p><b>5</b></p> <p>二极管开关<br/>LMSW43C系列</p>  <p>4.9x3.2x2.0mm</p>     | <p><b>6</b></p> <p>RF副组件<br/>RZWJG5G80CMAB00**</p>  <p>7.6x6.5x1.5mm</p> | <p><b>7</b></p> <p>负温度系数热敏电阻<br/>NCP系列</p>  <p>0201-0805尺寸</p> |
| <p><b>8</b></p> <p>片状多层LC滤波器<br/>LFB31_SN系列</p>  <p>3.2x1.6x1.3mm</p> | <p><b>8</b></p> <p>PLL组件<br/>HFQS14系列</p>  <p>11.4x10.0x2.0mm typ.</p> | <p><b>8</b></p> <p>GIGAFIL®<br/>MB系列</p>                                |   |   |   |
| <p><b>9</b></p> <p>表面波滤波器<br/>MKFCJ40M0系列</p>  <p>3.8x3.8x1.4mm</p>   |   |  |   |   |   |
| <p>压电扩音器<br/>PKLCS1212E40A1-R1<br/>PKM13EPY-4000-A0</p>               | <p>RESOMICS®<br/>DRR系列</p>  <p>TEM模式谐振器</p>                            | <p>独石陶瓷电容器<br/>GRM系列<br/>GNM系列 (排列型)<br/>GJM系列</p>                      | <p>陶瓷振荡子(CERALOCK®)<br/>CSTCR_G系列<br/>CSTCE_G系列<br/>CSTCE_V系列</p>  | <p>片状铁氧体磁珠<br/>BLM系列</p>   | <p>微调电位器<br/>PVZ2系列<br/>PVZ3系列<br/>PVG3系列<br/>PVG5系列</p>     |
| <p>微调电容器<br/>TZR1系列<br/>TZS2系列<br/>TZY2系列</p>                         | <p>负温度系数热敏电阻<br/>NCP_0S系列</p>  <p>0402-0603尺寸</p>                      |  |   |   |   |